

This document downloaded from
vulcanhammer.net vulcanhammer.info
Chet Aero Marine



Don't forget to visit our companion site
<http://www.vulcanhammer.org>

Use subject to the terms and conditions of the respective websites.

UNIFIED FACILITIES CRITERIA (UFC)

MOORING HARDWARE INSPECTION



APPROVED FOR PUBLIC RELEASE; DISTRIBUTION UNLIMITED

UNIFIED FACILITIES CRITERIA (UFC)

MOORING HARDWARE INSPECTION

Any copyrighted material included in this UFC is identified at its point of use. Use of the copyrighted material apart from this UFC must have the permission of the copyright holder.

Indicate the preparing activity beside the Service responsible for preparing the document.

U.S. ARMY CORPS OF ENGINEERS

NAVAL FACILITIES ENGINEERING COMMAND (Preparing Activity)

AIR FORCE CIVIL ENGINEER CENTER

Record of Changes (changes are indicated by \1\ ... /1/)

Change No.	Date	Location

FOREWORD

The Unified Facilities Criteria (UFC) system is prescribed by MIL-STD 3007 and provides planning, design, construction, sustainment, restoration, and modernization criteria, and applies to the Military Departments, the Defense Agencies, and the DoD Field Activities in accordance with [USD \(AT&L\) Memorandum](#) dated 29 May 2002. UFC will be used for all DoD projects and work for other customers where appropriate. All construction outside of the United States is also governed by Status of Forces Agreements (SOFA), Host Nation Funded Construction Agreements (HNFA), and in some instances, Bilateral Infrastructure Agreements (BIA.) Therefore, the acquisition team must ensure compliance with the most stringent of the UFC, the SOFA, the HNFA, and the BIA, as applicable.

UFC are living documents and will be periodically reviewed, updated, and made available to users as part of the Services' responsibility for providing technical criteria for military construction. Headquarters, U.S. Army Corps of Engineers (HQUSACE), Naval Facilities Engineering Command (NAVFAC), and Air Force Civil Engineer Center (AFCEC) are responsible for administration of the UFC system. Defense agencies should contact the preparing service for document interpretation and improvements. Technical content of UFC is the responsibility of the cognizant DoD working group. Recommended changes with supporting rationale may be sent to the respective DoD working group by submitting a Criteria Change Request (CCR) via the Internet site listed below.

UFC are effective upon issuance and are distributed only in electronic media from the following source:

- Whole Building Design Guide web site <http://www.wbdg.org/ffc/dod>.

Refer to UFC 1-200-01, *DoD Building Code*, for implementation of new issuances on projects.

AUTHORIZED BY:



CHRISTINE T. ALTENDORE, PhD,
P.E., SES
Chief, Engineering and Construction
U.S. Army Corps of Engineers

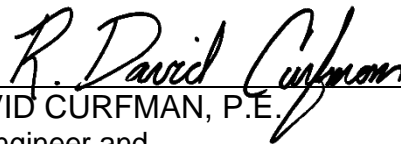

R. DAVID CURFMAN, P.E.
Chief Engineer and
Assistant Commander for Capital Improvements
Naval Facilities Engineering Command

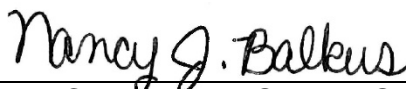

NANCY J. BALKUS, P.E., SES, DAF
Deputy Director of Civil Engineers
DCS/Logistics, Engineering &
Force Protection (HAF/A4C)
HQ, United States Air Force



MICHAEL McANDREW
Deputy Assistant Secretary of Defense
(Construction) and Acting Deputy Assistant
Secretary of Defense (Housing) Office of the
Assistant Secretary of Defense (Sustainment)

**UNIFIED FACILITIES CRITERIA (UFC)
REVISION SUMMARY SHEET**

Document: UFC 4-150-08, *Mooring Hardware Inspection*

Superseding: UFC 4-150-08 Change 1, dated 19 June 2001

Description: This UFC provides guidance for the specialized inspection and testing of mooring hardware at waterfront facilities and related facilities. Inspection levels, methods, and testing procedures are presented for the mooring hardware. The testing procedures presented herein are a precursor for a more detailed load capacity assessment of specified mooring hardware. The resulting findings of inspections of mooring hardware and fendering are to guide facility personnel in the selection of appropriate analysis, repair and replacement techniques, maintenance, inspection of fieldwork for acceptability, and planning the follow-on inspection requirements.

Reasons for Document:

- Document was due for revision.
- Provides coordination with ASCE MOP130, *Waterfront Facilities Inspection and Assessment*.
- Mooring condition ratings updated and coordinated with other UFCs. Mooring hardware testing procedures updated.
- Several references had been superseded and required updating.

Impact:

- This UFC is a guide for the inspection and evaluation of mooring hardware used at waterfront facilities that provide berthing for U.S. Military Ships.

Unification Issues:

- None.

TABLE OF CONTENTS

CHAPTER 1 INTRODUCTION	1
1-1 BACKGROUND.	1
1-2 PURPOSE AND SCOPE.	1
1-3 APPLICABILITY.	1
1-3.1 Facilities Covered.	2
1-3.2 Facilities Not Covered.	2
1-4 GENERAL BUILDING REQUIREMENTS.	2
1-5 GLOSSARY.	2
1-6 REFERENCES.	2
CHAPTER 2 PLANNING FACILITY INSPECTION	3
2-1 MAINTENANCE PLANNING.	3
2-2 PLANNING.	3
2-2.1 General.	3
2-2.2 Scope of Work.	3
2-2.3 Existing Data.	3
2-3 FIELD INSPECTION / DATA GATHERING.	4
2-3.1 General.	4
2-3.2 Field Inspection.	5
2-4 ENGINEERING EVALUATION.	6
2-5 TYPE OF MOORING SERVICE.	6
CHAPTER 3 QUALIFICATIONS	13
3-1 PERSONNEL.	13
CHAPTER 4 INSPECTION FUNDAMENTALS	15
4-1 LEVELS OF INSPECTION.	15
4-1.1 Level 1 - Walk through Inspection.	15
4-1.2 Level 2 - Visual Inspection.	15
4-1.3 Level 3 - Detailed Inspection.	15
4-1.4 Fender System.	15
4-2 FREQUENCY OF INSPECTION.	16
4-3 INSPECTION METHODS.	16
4-3.1 Local Conditions.	16
4-3.2 Fasteners.	16

4-3.3	Supporting Structure.....	17
4-3.4	Fender System.....	17
4-3.5	Global Conditions.....	18
4-4	PHOTOGRAPHY.....	19
CHAPTER 5 REPORT		21
5-1	REPORT PURPOSE AND OBJECTIVES.....	21
5-2	REPORT FORMAT.....	21
5-3	REPORT STRUCTURE.....	21
5-3.1	Outline.....	21
5-3.2	Introduction.....	21
5-3.3	Activity Description.....	21
5-3.4	Facilities Inspected.....	22
5-3.5	Facilities Description.....	22
5-3.6	Design Structural Capacity.....	22
5-3.7	Existing Condition.....	22
5-3.8	Appendices.....	22
5-4	3D MODEL.....	23
5-5	DRAWINGS.....	23
5-6	DATA TABLES.....	24
APPENDIX A MOORING HARDWARE TESTING		27
A-1	INTRODUCTION.....	27
A-1.1	Scope.....	27
A-1.2	Purpose.....	27
A-2	PLANNING HARDWARE TESTING PROGRAM.....	27
A-2.1	General Description.....	27
A-2.2	Scope of Work.....	27
A-2.3	Existing Data.....	28
A-2.4	Site Conditions.....	28
A-2.5	Testing Plan.....	28
A-2.6	Facility Prioritization.....	29
A-3	QUALIFICATIONS.....	31
A-3.1	Personnel.....	31
A-4	BACKGROUND.....	31

A-4.1	General.	31
A-4.2	Load Path.	31
A-4.3	Supporting Structures.....	32
A-4.4	Failure Modes.....	32
A-5	METHODS.....	32
A-5.1	General.	33
A-5.2	Results.....	33
A-5.3	Levels of Load Testing.....	34
A-5.4	Testing Procedure.	34
A-6	REPORTING.	37
APPENDIX B	GLOSSARY	39
B-1	ACRONYMS.....	39
APPENDIX C	REFERENCES.....	41
C-1	GOVERNMENT PUBLICATIONS.	41
C-2	NON-GOVERNMENT PUBLICATIONS.	41

FIGURES

Figure 2-1	Mooring Hardware Inspection Process.....	7
Figure 2-2	Mooring Hardware Inspection Record	8
Figure 2-3	Typical Profiles of Mooring Hardware.....	9
Figure 2-4	Condition Rating Scale for Mooring Hardware	10
Figure 2-5	Condition Rating Scale for Base Structure.....	11
Figure 5-1	Report Outline.....	25
Figure A-1	Example Deck Fitting Load Test Report	35

TABLES

Table 5-1	Condition of Color Schemes.....	24
Table A-1	Pull Testing Interval Recommendations.....	30

This Page Intentionally Left Blank

CHAPTER 1 INTRODUCTION

1-1 BACKGROUND.

This UFC 4-150-08, is a guide for the inspection and evaluation of mooring hardware used at waterfront facilities that provide berthing for U.S. Military Ships. It is a source of reference for the planning, inspection, and reporting of mooring hardware conditions in a standardized format.

Initial chapters in this UFC provide a summary of responsibilities and policies, field inspection guidelines, and mooring hardware types. Inspection levels, methods, planning, and techniques and checklists are covered for above water inspection. General load capacity testing procedures are described and illustrated for general mooring hardware.

1-2 PURPOSE AND SCOPE.

This UFC provides guidance for the planning, inspection, assessment, and reporting of mooring hardware conditions. It should be used as a tool for helping personnel tasked with maintaining the readiness of shore side facilities for use by the fleet and in support of military marine operations. The Mooring Hardware Report has the following objectives:

- Establish adequacy of mooring facilities.
- Enable facility users to develop efficient berthing plans.
- Establish baseline data on existing mooring hardware and berthing capacity.
- Provide facility users with information sufficient to determine level of effort to maintain or upgrade existing capacity.

1-3 APPLICABILITY.

This UFC provides guidance for the specialized inspection and testing of mooring hardware at waterfront facilities and related facilities. Inspection levels, methods, and testing procedures are presented for the mooring hardware. The testing procedures presented herein are a precursor for a more detailed load capacity assessment of specified mooring hardware. The resulting findings of inspections of mooring hardware and fendering are to guide facility personnel in the selection of appropriate analysis, repair and replacement techniques, maintenance, inspection of fieldwork for acceptability, and planning the follow-on inspection requirements.

The standards and methods presented herein are a guide to the planning, inspection, assessment, and reporting of mooring hardware conditions. The standards and methods outlined have been developed from the best technical sources in industry and the military services.

1-3.1 Facilities Covered.

Types of facilities covered as related to mooring hardware include:

- Berthing facilities (piers, wharves, and dolphins) for mooring and for providing support to ships and craft.
- Dry docks used for modification, inspection maintenance, and repair of ships.

1-3.2 Facilities Not Covered.

Facilities not covered in this UFC are:

- Fleet moorings - which are covered in UFC 4-150-09, *Permanent Anchored Moorings: Operations and Maintenance*.
- Mechanical capstans.

1-4 GENERAL BUILDING REQUIREMENTS.

Comply with UFC 1-200-01, *DoD Building Code*. UFC 1-200-01 provides applicability of model building codes and government unique criteria for typical design disciplines and building systems, as well as for accessibility, antiterrorism, security, high performance and sustainability requirements, and safety. Use this UFC in addition to UFC 1-200-01 and the UFCs and government criteria referenced therein.

1-5 GLOSSARY.

APPENDIX B contains acronyms, abbreviations, and terms.

1-6 REFERENCES.

APPENDIX C contains a list of references used in this document. The publication date of the code or standard is not included in this document. Unless otherwise specified, the most recent edition of the referenced publication applies.

CHAPTER 2 PLANNING FACILITY INSPECTION

2-1 MAINTENANCE PLANNING.

Maintenance planning criteria can be found in Chapter 2 of UFC 4-150-07, *Waterfront Facilities Operations and Maintenance*. Development of a long-term inspection and maintenance program involving all aspects of waterfront facilities is covered in the above document. A long-term inspection program involving regular field inspection of mooring hardware at established intervals should be part of the overall facility maintenance program.

2-2 PLANNING.

2-2.1 General.

This section covers the planning required to conduct an inspection and assessment of mooring hardware. Critical aspects of planning an inspection of this nature include the establishment of a clear scope of work and gathering all available data. Figure 2-1 depicts the Mooring Hardware Inspection Process.

2-2.2 Scope of Work.

Planning the inspection of mooring hardware will begin with the establishment of a scope of work. The scope of work will define the facilities to be inspected and level of inspection. The scope of work should include:

- Number of hardware.
- Type of hardware.
- Type of support structure.
- Level of inspection required.
- Date of last inspection.
- Fender system type and quantity.
- List of ships that normally use hardware, (i.e. mission critical ships).

2-2.3 Existing Data.

All available relevant data on the facilities to be inspected and assessed should be gathered at the earliest possible date. This information should be provided to the persons responsible for planning and organizing the inspection and assessment effort such that the level of effort for inspecting a specific facility can be determined. Data and information may be available in many forms as listed below.

2-2.3.1 Drawings.

- As-Built Construction Drawings – Original construction drawings will often have vital information regarding mooring and berthing design loads. This information is usually the most accurate data available to the inspector. Caution should be taken to confirm that the data on the plans is accurate and changes to the structure have been investigated and confirmed.
- Repair and Maintenance Drawings – All modifications to the original structure should be investigated and analyzed as to their impact to the structure.
- Site Plans – Site plans can provide layout data and, in some cases, will have sufficient detail to show mooring hardware position. This data is often out dated and should be confirmed.
- Hydrographic Survey Plans – Hydrographic data is important to establish depth of water at the berth.

2-2.3.2 Calculations.

Design calculations to establish the capacity of the supporting structure. Calculations used to determine loads on hardware.

2-2.3.3 Existing Reports.

Previous inspection reports such as a Waterfront Facilities Inspection Report, Prior Mooring Hardware Condition report or Annual Inspection Summaries.

2-3 FIELD INSPECTION / DATA GATHERING.

2-3.1 General.

The purpose of any mooring hardware inspection is to gather information to assess the condition of the mooring hardware system inspected. The level of inspection will determine the amount and type of information gathered. The inspection will focus on gathering the following information:

- Identification of damage.
- Confirmation of available data.
- Changes in the known supporting structure.
- Identification of potential problems with interacting equipment and fixtures.
- Establishing the position of mooring hardware and fenders.
- General condition of fender system and hardware.
- Gather available background information at the site.

2-3.2 Field Inspection.

Personnel assigned to conduct a field inspection of mooring hardware should acquire the appropriate tools necessary to accomplish the work. The level of inspection will dictate the required tools. All levels require appropriate record keeping. Information should be recorded in logbooks. The time and level of effort required to conduct an inspection will depend on the amount of background information that is available, level of inspection required, site conditions, site access and activity, as well as the skill of the inspector.

2-3.2.1 Tools Required.

2-3.2.1.1 Hand Tools.

Various hand tools are required to accomplish the task of inspecting mooring hardware. Tape rules, folding rules, measuring wheels, and in some instances surveying equipment will be required to perform tasks such as: dimensioning structural components, finding the position of mooring hardware, and measuring distress within the structural system. Other tools such as wire brushes, chipping hammers, and scrapers can be used to clean and uncover structural components that are not readily visible. Marking devices such as paint stick, keel, paint, and ink pens can be used to establish identifying marks on each hardware unit for reference.

2-3.2.1.2 Equipment.

Heavy equipment may be required to conduct Level 3 Inspections. Equipment such as diving gear, compressions, jacks, hoists, rigging, load cells, and cranes should be used as necessary to accomplish the work.

2-3.2.1.3 Note Keeping.

Field inspection data and notes should be kept in a surveyor's field book or the Mooring Hardware Inspection Sheet (see Figure 2-2) and in an orderly and legible fashion. Photographic documentation of each piece or representative piece of mooring hardware should be taken and recorded in the field book. Notes can be kept in tabular form within the notebook. The following minimum data is required:

- Hardware Number or Designation – Each fitting should have a unique alphanumeric designation. If an existing system is in place it should be used. If there is no system for identifying hardware, unique designations should be assigned. For example, identifying systems such as “B1-C3” for Berth 1, Cleat Number 3 may be used.
- Size and Type of Hardware – Record the casting number or serial number that identifies each type of hardware. Standard U.S. Navy fittings can be found in Figure 2-3 (see Table 6-11 and Figure 6-3 in UFC 4-159-03). If the hardware number cannot be found or identified in the field, then the overall dimensions should be recorded.

Additional information concerning the sizes and working capacities of pier and wharf mooring fittings is found in UFC 4-159-03, *Moorings*. Further information on inspection can be found in ASCE MOP 130, *Waterfront Facilities Inspection and Assessment*.

- Position of hardware (X, Y, Z coordinates) – A coordinate system should be identified and established such that the location of each hardware can be established along the berth. The relationship between the hardware and the tidal datum should also be established.
- Reference position of coordinates – All coordinate systems should be referenced to a local system for each facility i.e. reference benchmark on site, or activity base map coordinates.
- Condition of the hardware – The condition of each piece of mooring hardware should be rated in the field. The rating system should be on a scale of 1 to 5, as described in Figure 2-4.
- Condition of the base structure – The base structure of each piece of hardware should be rated on a scale of 1 to 5, as described in Figure 2-5.
- Condition of the fender system should be noted and rated as described in UFC 4-150-07.
- Fasteners – The number, pattern and size of the fasteners on each piece of mooring hardware should be recorded.
- Additional remarks – Additional notes such as odd conditions, qualifying remarks, and other information that might be deemed useful should be recorded.
- Photo identification number and description.
- All sketches and other ancillary notes should be kept in the same notebook.

2-4 ENGINEERING EVALUATION.

An evaluation of the data can only be conducted once the inspection is complete. The field data as well as the existing data should be reviewed and analyzed to formulate allowable load criteria.

2-5 TYPE OF MOORING SERVICE.

The type of mooring service should be considered when planning the inspection frequency. For example, Berths with Mooring Service Type III should be considered high priority as ships moored at these berths may not have the ability to get under way in case of an approaching storm. See Table 3-4 in UFC 4-159-03, *Moorings* for an explanation of mooring service types (MST).

Figure 2-1 Mooring Hardware Inspection Process

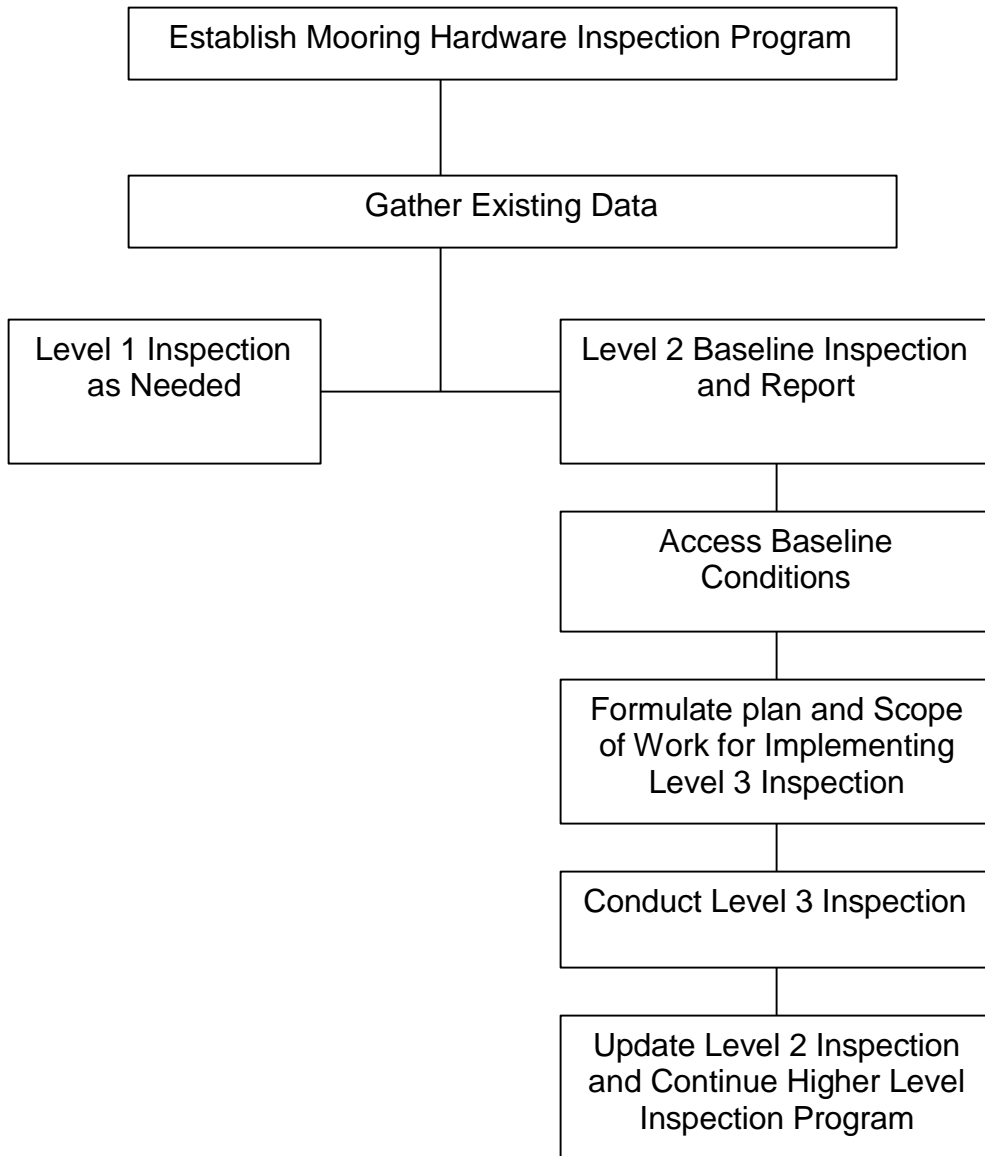

Figure 2-2 Mooring Hardware Inspection Record

<u>MOORING HARDWARE INSPECTION RECORD</u>									
LOCATION						DATE:			
FACILITY NAME						COORDINATE REFERENCE / BENCHMARK			
INSPECTOR						LEVEL OF INSPECTION			
Hardware Designation	Description	Design Capacity	X Coord	Y Coord	Z Coord	Condition Rating		Photo #	Comments
						Hardware	Base Str.		

Figure 2-3 Typical Profiles of Mooring Hardware

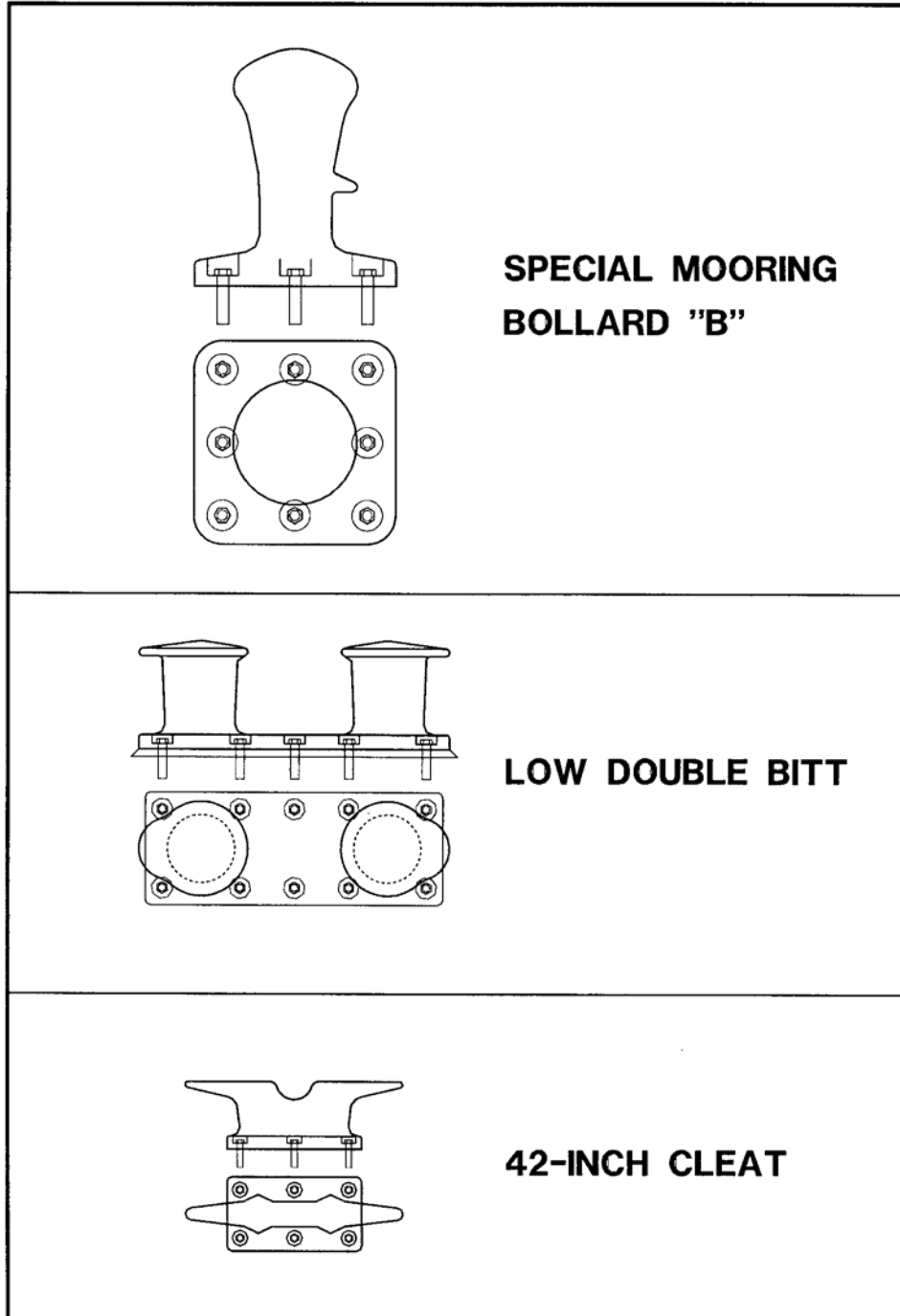

Figure 2-4 Condition Rating Scale for Mooring Hardware





Example of Condition	Mooring Hardware Condition Rating
	#1 <u>No Defects:</u> <ul style="list-style-type: none">• Material and connections sound• Less than 10% surface corrosion• Surface coating in good condition• Bolt countersinks grouted or sealed
	#2 <u>Minor Defects:</u> <ul style="list-style-type: none">• Surface corrosion over 10-25% of area• Minor wear marks or pitting are less than 1/8 in. (3.2 mm) deep• Minor corrosion of fasteners with no significant section loss
	#3 <u>Moderate Defects:</u> <ul style="list-style-type: none">• Surface corrosion with loose scale over 25-50% of its area• Moderate wear marks or pitting are less than 1/4 in. (6.4 mm) deep• Fasteners corroded with less than 25% section loss
	#4 <u>Major Defects:</u> <ul style="list-style-type: none">• Surface corrosion with loose scale over 50% or more of its area and/or less than 25% section loss• Significant wear marks or pitting are 1/4 in. (6.4 mm) deep or greater• Fasteners corroded with loose scale or greater than 25% section loss
	#5 <u>Severe Defects:</u> <ul style="list-style-type: none">• Heavy surface corrosion and loose scale with greater than 25% section loss at critical areas• Movement, rotation, or deformation of fitting; components are broken, cracked, or delaminated• Loose, missing, or broken fasteners

Figure 2-5 Condition Rating Scale for Base Structure

Example of Condition



Mooring Foundation Condition Rating

- #1 No Defects:
- Good original sound condition with no visible defects
- #2 Minor Defects:
- Hairline cracks in concrete from thermal expansion, mooring hardware corrosion, and/or age; no significant section loss
 - Light surface corrosion of steel, no significant section loss, coating weathered
 - Timber or composite weathered; presence of fungal decay; minor checks, splits, and gouges up to 1/4 in. (6.4 mm) wide
- #3 Moderate Defects:
- Noticeable cracking of concrete without loss of interlock
 - Steel corrosion with less than 10-25% section loss
 - Timber or composite cracked or checked up to 1/2 in. (12.7 mm) wide, weathered surfaces, fungal decay with section loss up to 1 in. (25.4 mm)
- #4 Major Defects:
- Noticeable cracking or spalling of concrete with loss of interlock
 - Steel corrosion with 25-50% section loss
 - Timber cracked or checked greater than 1/2 in. (12.7 mm) wide; fungal decay up to 3 in. (76.2 mm) deep; dry rot
 - Composite elements cracked or split
- #5 Severe Defects:
- Displacement or yielding; loss of full bearing
 - Major cracking or spalling of concrete base under hardware
 - Significant corrosion of steel members with greater than 50% section loss at any location
 - Timber members broken or damaged or fungal decay greater than 3 in. (76.2 mm)
 - Composite elements broken or damaged

This Page Intentionally Left Blank

CHAPTER 3 QUALIFICATIONS

3-1 PERSONNEL.

If a contract is used, the inspection of mooring hardware must be conducted under the supervision of a Registered Professional Engineer (P.E.) who has experience in the design and inspection of marine structures. At a minimum, the supervising engineer (P.E.) must be onsite and involved in the inspection to assess and record conditions encountered using standard engineering practice. Level 1 inspections may be conducted by technicians under the supervision of a Registered Professional Engineer. For Level 2 or Level 3 inspections, which may require underwater inspection as well as the operation of equipment, personnel must be fully qualified and should have adequate levels of support to accomplish the task. All work operations must be accomplished in accordance with the standards identified in APPENDIX C. Guidance for underwater inspections can be found in UFC 4-150-07, *Waterfront Facilities Operations and Maintenance*.

This Page Intentionally Left Blank

CHAPTER 4 INSPECTION FUNDAMENTALS

4-1 LEVELS OF INSPECTION.

4-1.1 Level 1 - Walk through Inspection.

This inspection is a walk-through inspection to assess damage following a storm event and to confirm any changed conditions. Gross deficiencies can be identified during this inspection. This level of inspection cannot provide sufficient data to assess the capabilities of a mooring system.

4-1.2 Level 2 - Visual Inspection.

This inspection will involve visual observation of the condition of exposed components of the mooring hardware and supporting structure. The hardware should be visually inspected for cracks or other anomalies. Hardware geometry should also be inspected to determine if displacement has occurred. Bolts, if exposed, can be inspected to determine their relative tightness. The general condition of the supporting base structure should be inspected for anomalies such as cracking and/or displacement. Under this level of inspection, the position of the hardware should be determined. The relative position in relation to the three principal axis coordinates (X, Y, Z) should be established to the nearest foot. The Level 2 visual inspection is required to establish baseline conditions.

4-1.3 Level 3 - Detailed Inspection.

This inspection is performed in addition to the inspection tasks performed under the Level 1 and Level 2 inspections. A detailed inspection will involve the observation of exposed components of the supporting structure such as the underside of the pier deck and piles.

In addition, a detailed inspection may involve partly destructive techniques related to dismantling and load testing mooring hardware. Removal of sealing material and fasteners for inspection and load testing will be accomplished as directed by the Scope of Work under this level of inspection. Individual fasteners may be load tested in tension by using a jacking apparatus. The entire hardware piece may be load tested using various methods. The method employed for load testing of hardware will be dependent upon the type of hardware piece and site conditions. Guidelines for load testing hardware and fasteners can be found in APPENDIX A of this document.

4-1.4 Fender System.

A Level 1 visual inspection of the fender system should be conducted concurrently with all levels of mooring hardware inspection. The type of fender system will be noted, and the general configuration will be established as it relates to the mooring hardware. Size and location of fender system components will be noted to determine the placement of ships.

4-2 FREQUENCY OF INSPECTION.

Under most circumstances, all mooring hardware in satisfactory or better condition should receive a Level 1 Inspection annually, and a Level 2 maximum inspection interval of 4 to 6 years, depending upon the aggressiveness of the environment and the level of hardware protection. The type of structure and the class of service will also dictate the inspection frequency and level of inspection. For timber structures that are susceptible to impact and severe environmental conditions the frequency of Level 2 inspections should be set at every 3 years. For structures that are high priority, the berthing officer will determine the level of inspection. In instances where extreme storm events have resulted in the potential overloading of mooring hardware, a Level 1 inspection should be conducted to determine post storm conditions. Level 3 Inspections involving load testing should be conducted as directed by the Berthing Officer or as described in APPENDIX A, based on hardware priority level.

4-3 INSPECTION METHODS.

4-3.1 Local Conditions.

4-3.1.1 Mooring Hardware Fittings.

Each piece of mooring hardware should be visually inspected for anomalies. Conditions that are commonly found include cracks, abrasion (due to wire rope), corrosion and displacement. Cracks are usually the result of impact loading or overloading the hardware under extreme conditions. Abrasion normally occurs when mooring lines are pulled around the hardware causing friction and erosion of the casting under the barrel or horn. If this condition is severe, it will weaken the casting through loss of cross sectional area. Documentation of the depth of abrasion, location, and area are required to establish loss of strength. The condition of the coating should be noted. Coatings that have mechanical damage, i.e., cracks, peeling, or abrasion, should be described. Coating systems that have failed or are worn out should also be described, as well as any resulting corrosion. Levels of corrosion can be described as rust stains, light scale, and heavy scale. The surface roughness of the steel should also be described. Corrosion of the casting should be assessed to determine the loss of section at critical points on the casting. Heavy corrosion will also affect the surface roughness of the hardware increasing the chafing and wearing of mooring lines. Observations of the mooring hardware plumbness and level should be made to determine prior overloading and failure of the surrounding soil or fasteners.

4-3.2 Fasteners.

Fasteners consisting of steel bolts are used to anchor the mooring hardware to the supporting structure. In some cases, mooring hardware is embedded directly in the supporting structure. Where fasteners are used, their function within the mooring system is critical and is almost always the crucial structural element. Fasteners are generally inaccessible because of typical mooring hardware details, calling for protection usually in the form of lead fill, bituminous fill or grout being placed in the bolt pockets. If the fasteners are not visible, then a Level 1 or 2 inspection will result in

minimal fastener data. A Level 3 inspection is required to determine the condition of the fasteners. For newer structures, the fasteners may pass through blocking and terminate with nuts and washers bearing on heavy plates. This part of the structure is accessible and should be inspected for loss of section due to corrosion. If fasteners are embedded in the structure and the bolt pockets are filled, the only inspection technique available to the inspector is to remove the casting and observe the fastener for corrosion and loss of cross sectional area. Load testing of the fasteners can be conducted without removal of the casting and will result in the determination of an allowable load. See APPENDIX A for load testing criteria.

4-3.3 Supporting Structure.

4-3.3.1 Concrete.

The majority of heavy load mooring hardware is attached to concrete decks. Concrete acts well to resist the forces applied by mooring hardware. The compressive strength of concrete resists the shear forces generated as well as providing excellent distribution of load through the structure. Factors to consider when inspecting concrete that supports mooring hardware include cracking, disintegration and corrosion of reinforcing steel. Cracking occurs in all concrete through many processes both as a result of natural factors and from outside forces such as impact. The inspector must be able to determine the differences between the various types of cracks, their causes and the structural implications of those cracks. Cracks of a concerning nature include: shear cracks near the edge of the pier deck (running at 45 degrees through the corner); diagonal cracking on the deck surface running at 45 degrees from the hardware to the edge; and radial cracking around fasteners indicating cone failure. Gaps at the hardware base or crushing of bedding grout indicate movement or overloading and should be noted. General deterioration of the concrete should be observed and noted.

The mooring hardware should be founded on a solid concrete matrix and/or bedded in grout to provide full contact on the bottom and sides. The concrete should be solid and not exhibit any significant disintegration or spalling.

4-3.3.2 Timber.

Timber structures should be inspected for structural failures such as: crushing of the timber under the hardware or the fastener bearing plates, cracking or failed members, and displaced members. Timber also exhibits deterioration in several forms such as: dry rot or decay, marine borers, and termites or other insects. These conditions should be noted and assessed based on their impact to the structure and mooring hardware.

4-3.3.3 Steel.

Steel supporting structures exhibit conditions such as corrosion, buckling, and cracking. Steel members are generally fastened with either bolts or welds. Bolts should be inspected for tightness, loss of cross sectional area due to corrosion, and bearing. Welds should be inspected visually for cracking.

4-3.4 Fender System.

Visual observation of the fender system should be made in sufficient detail to establish the typical cross-section and to detail the energy absorbing characteristics of the system. Where timber fender systems are employed, the general condition of the timber components should be noted in terms of berthing capability. Where other types of fender systems are in place, the overall capacity of the system should be documented. Locations where damage has occurred should be noted. Missing fender units should be noted and identified.

4-3.5 Global Conditions.

Global conditions refer to the condition of the supporting pier, wharf, or dolphin structure. The inspection of these structures is closely related to the condition of the mooring hardware with respect to the capacity of the mooring system. For example, the sum of the capacities of the mooring hardware may exceed the total capacity of the structure to resist these loads. In this case the mooring hardware cannot be fully developed. Berthing plans are required to factor these limitations into the allowable berthing capacity for the facility. Inspection of pier facilities is addressed in UFC 4-150-07, *Waterfront Facilities Operations and Maintenance*.

4-3.5.1 Pier Structure.

The significant loading imposed on the pier structure by mooring hardware is in the lateral direction (horizontal “x” direction), which in most cases is resisted by batter piles or passive earth pressure. Piers vary in their construction and the methods employed to transmit these loads to the soil. Open pier structures generally have battered piles (piles at an angle) along with plumb piles (vertical piles,) as well as significant dead loads to resist the lateral and resulting uplift loads. Solid pier structures rely on their massive dead load for stability, as in cellular structures or in the resistance of deadman in the case of tied-back sheet pile bulkheads.

4-3.5.2 Structural Analysis.

The inspecting engineer must collect all available data to ascertain the capacity of the pier structure to resist lateral loads. Available information may include:

- Original design drawings and calculations.
- Modifications to the structure.
- Previous inspection reports.

4-3.5.2.1 Calculations.

When directed, a licensed professional engineer must calculate the lateral capacity of the facility based on available data and according to UFC 4-152-01, *Piers and Wharves*. For each ship that uses the facility, the analysis should provide the maximum wind speed for safe mooring. Caution should be exercised in using appropriate factors of safety based on the accuracy and scope of available data.

4-4 PHOTOGRAPHY.

Photography should be used to document the condition of each piece of hardware. This can be used in future assessments to determine the change in conditions. Photographs should include a general overview of the hardware piece and any significant conditions. The hardware should be identified within the photograph. An overview of each berth showing the fender system should be taken and included within the report.

This Page Intentionally Left Blank

CHAPTER 5 REPORT

5-1 REPORT PURPOSE AND OBJECTIVES.

The mooring hardware report should present the data acquired during the field investigation and the results of the analysis of that data for the use by Berthing Officers in the formulation of berthing plans, scheduling repairs, and instituting a mooring hardware load test program.

5-2 REPORT FORMAT.

For consistency, all reports should follow the Report Outline in Figure 5-1. The contents of each section are described below. Each report should be submitted in MS Word (.doc) and Adobe Acrobat (.pdf). The quantity of each submittal should be determined in the scope of work. The digital files should be submitted on CD-ROM media or other approved file transfer system.

5-3 REPORT STRUCTURE.

5-3.1 Outline.

See Figure 5-1.

5-3.2 Introduction.

This section is largely a descriptive overview with sections including:

- 1.1 Background/Objectives
- 1.2 Report Description
- 1.3 Condition Rating
- 1.4 Digital Model

5-3.3 Activity Description.

This section has subsections including:

- 2.1 Location
- 2.2 Existing Waterfront Facilities along with regional, area, and facility maps that are the same as in the Waterfront Facilities Inspection Report.

Additional subsections include:

- 2.3 Inspection Procedure and
- 2.4 Hardware Numbering System

In these subsections, the inspection procedure and hardware numbering system are explained in detail to the reader. In the inspection procedure subsection, the condition

rating system is described as well as the method of locating the position of the mooring hardware. This will provide the reader with an understanding of the level of accuracy of the inspection and data. The subsection on the Hardware Numbering System will provide the reader with an understanding of the system used and why this system was employed, (i.e. whether the system was in place or developed for a specific inspection).

5-3.4 Facilities Inspected.

This section constitutes the body of the report and has the following subsections:

- 3.1.1 Description
- 3.1.2 Design Structural Capacity
- 3.1.3 Existing Condition

5-3.5 Facilities Description.

Includes a summary of the history of the facility structure including the date of original construction, type of structure, length of berth, deck elevation, depth of water (MLLW datum), and a description of the fender system. The intent of this section is to give the reader a solid background on the specifics of the structure while being concise. In addition to structure description, the current use of the facility should also be described. The types of vessel usage complement as well as the type of service (I, II, III, or IV) should be noted. See UFC 4-159-03, *Moorings*.

5-3.6 Design Structural Capacity.

This section consists of a table reviewing mooring hardware data associated with the facility. The data within this table includes: mooring hardware type and quantity, design load rating of the hardware, the calculated load capacity of the hardware if manufacturer's data is not available, and the design and/or calculated capacity of the base structure. This table is a structural summary intended to provide the reader with information required to determine berthing capacity.

5-3.7 Existing Condition.

This section provides a summary of the conditions found during the inspection. A discussion of hardware rated at #3 or #4 is included to highlight conditions that warrant attention. Following the existing condition text are photo pages that present a photographic example of each type of hardware found on the facility and photos of anomalous conditions. Following the photo page(s) is the figure showing the 3-D perspective view of the facility (when requested). Following this is the figure (drawing) showing the plan view of the facility with the condition of the fittings and fender system noted. Following this is the data table. The data table has all the information available about each piece of mooring hardware. This information includes; hardware #, node #, X-coord., Y-coord., Z-coord., type of hardware, line pull rating, and the condition of both the hardware and its support structure.

5-3.8 Appendices.

5-3.8.1 Key Personnel.

Each report should have a list of key personnel responsible for organizing, conducting, and implementing the investigation.

5-3.8.2 Load Test Procedures.

This section will include a description of any load testing undertaken. The level of testing, quantity, and location of load tests will be described (see APPENDIX A).

5-3.8.3 Calculations.

All calculations to determine the load capacity of mooring hardware and/or supporting structures is presented in APPENDIX A.

5-3.8.4 Mooring Hardware Inspection Records.

The actual mooring hardware inspection records should be included in this section.

5-3.8.5 Deck Fitting Load Test Reports.

The load testing reports should be presented in this section.

5-3.8.6 References.

All references used in the body of the report should be identified in this section.

5-4 3D MODEL.

A three-dimensional model of each facility will be generated when requested for Level 2 inspections in AutoCAD 2010 or greater to assist facility users in the placement of ships and camels along the pier or wharf in conjunction with fender systems that are in place. At a minimum the model must include: all mooring hardware, main components of the permanent fender system, mudline representation, water level representation, and all fixtures and buildings within 50 feet (15.2 m) of the berth face or that would cause obstruction to berthing lines. A perspective view of the berth should be presented in the body of the report for each facility in the form of a figure in 8.5 in. x 11 in. (216 mm x 279 mm) format.

5-5 DRAWINGS.

The report will include plan views of each berth showing the location of each mooring hardware piece with the hardware identification number as well as its condition. The condition of the hardware should be color-coded to match the color-coding of the data tables. The condition of the fender system should also be noted with a color line running parallel to the face of the berth. The plans will be to scale such that laying out mooring lines can be planned and facilitated.

Obstructions to mooring lines will also be shown on the plan. The north arrow and direction of current ebb and flood will also be shown.

5-6 DATA TABLES.

Data tables will be included in the report and in spreadsheet format. At a minimum the data tables will include: X, Y, Z coordinates of each piece of hardware, its identification number, its node number, the condition of the hardware and its base, the type of hardware, and its allowable line pull rating. The hardware condition will be annotated both numerically and in color as noted in Table 5-1. The data table will be produced in Excel format as shown and should have the ability to be manipulated in to the EMOOR database (see UFC 4-159-03, *Moorings*) The node number, coordinates, and the line pull should be numbers (not labels) to facilitate import into a database in Excel format.

Table 5-1 Condition of Color Schemes

Condition Color Level	Color	AutoCAD 2010 Color Number
1 = Excellent	Green	90
2 = Satisfactory	Blue	160
3 = Marginal	Yellow	40
4 = Poor	Red	240

Figure 5-1 Report Outline

Report Cover Title	
Page	
Executive Summary	
Table of Contents	
List of Figures	
List of Photographs	
List of Tables and Data	
Section 1.0 Introduction	
1.1 Background/Objectives	
1.2 Report Description	
1.3 Condition Rating	
1.4 Digital Model	
Section 2.0 Activity Description	
2.1 Location	
2.2 Existing Waterfront Facilities	
2.3 Inspection Procedure	
2.4 Hardware Numbering System	
Section 3.0 Facilities Inspected	
3.1 Facility No. 1	
3.1.1 Description	
3.1.2 Design Structural Capacity	
3.1.3 Existing Condition	
3.2 Repeat as necessary	
Appendices	
A. Key Personal	
B. Load Test Procedures	
C. Calculations	
D. Mooring Hardware inspection Records	
E. Deck Fitting Load Test Reports	
F. References	

This Page Intentionally Left Blank

APPENDIX A MOORING HARDWARE TESTING

A-1 INTRODUCTION.

A-1.1 Scope.

This Appendix is a guide for the testing of mooring hardware at waterfront facilities. It is a source of reference for the planning, testing, and reporting of current load capacities of mooring hardware at waterfront facilities in a standard format.

A-1.2 Purpose.

This Appendix provides guidance for the planning, testing, and reporting of current mooring hardware load capacities. It should be used as a tool for assisting personnel tasked with maintaining the readiness of shoreside facilities for use by the fleet and in support of military marine operations.

The objectives of the Mooring Hardware Report are:

- To establish adequacy of mooring facilities.
- Enable facility users to develop efficient berthing plans.
- Establish baseline data on existing mooring hardware and berthing capacity.
- Provide facility users with information sufficient to determine the level of effort necessary to maintain or upgrade existing capacity.
- This UFC covers berthing facilities for mooring and providing support to ships and craft, as well as dry docks used for modification, inspection, maintenance, and repair of ships.

This UFC does not cover fleet moorings (covered in UFC 4-159-03, *Moorings*) or mechanical capstans.

A-2 PLANNING HARDWARE TESTING PROGRAM.

A-2.1 General Description.

This section covers the planning required to conduct the testing of mooring hardware. Critical aspects of planning testing of this nature include the establishment of a clear scope of work and gathering all available data as well as understanding the prioritization of berths and fittings.

A-2.2 Scope of Work.

Planning the testing of mooring hardware will begin with the establishment of a scope of work. The scope of work will define the mooring hardware to be tested and the level of testing to be conducted. The scope of work should be made following initial findings of the Level 2 Inspection and Report (covered in UFC 4-159-03). The scope of work should include:

- Hardware to be tested, by established designation.
- Type of hardware.
- Type of support structure.
- Level of testing required.
- Accessibility.
- Date of last inspection/testing.

A-2.3 Existing Data.

All available relevant data on the mooring hardware to be tested should be gathered at the earliest possible date. This information should be provided to the persons responsible for planning and organizing the testing effort such that the level of effort for testing a specific piece of hardware can be determined. Data and information may be available in many forms as listed below:

- Mooring Hardware Inspection report.
- Design plans.
- Berth priority ratings.
- Hardware priority ratings.

A-2.4 Site Conditions.

The portion of the waterfront facility surrounding the mooring hardware to be tested should be evaluated for accessibility. If there are no limitations to accessibility of the mooring hardware, all options for testing should be considered. This information assists in formulating accurate cost estimates for the testing.

A-2.5 Testing Plan.

Testing of fittings is relatively expensive and time consuming, so it is recommended that periodic testing is used on a statistical basis. Prioritize the tests based on the importance of the mooring facility.

Various levels of testing can be instituted to achieve the desired results. For example, if it is determined that the required level of accuracy is 100%, then all fittings will need to be tested. If 95% accuracy is required, then the number of tests can be reduced significantly. The sampling criteria can be based on statistical sampling techniques.

Statistical sampling provides an objective method for determining sample size for a desired confidence level and precision. The result of a statistical sampling program would determine the approximate number of fittings that are marginal or unacceptable; however, it would not be able to determine the location of those fittings. An estimation of the load carrying capacity and condition of the fittings in general could be made.

Testing of every fitting would be required for 100% accuracy. A statistical approach may be a reasonable cost effective method of initiating a testing program that would determine the overall adequacy of the berthing system.

Standard sampling plans are presented in ANSI/ASQ Z1.9, *Sampling Procedures and Tables for Inspection of Variables for Percent Nonconforming* or ANSI/ASQ Z1.4, *Sampling Procedures and Tables for Inspection by Attributes* based on choice of inspection methods; inspection by variables or by attributes. ANSI/ASQ Z1.4 may be well suited for a testing program where the fittings are either passing or failing the load test.

A-2.6 Facility Prioritization.

Review mooring facilities and prioritize each mooring hardware unit as 'HIGH', 'MEDIUM' or 'LOW' to determine the extent of testing required. Consider the following factors in assigning testing priorities.

- Visual inspections and non-destructive testing (such as ultrasonic) may find possible problems and indicate that certain mooring fittings need to be assigned the highest priority. Visual inspections should include the fasteners (nuts and bolts) including the under-deck connections if available. Some mooring fittings should be taken out of service and should not be tested if the fasteners are in poor condition.
- Berths providing Mooring Service Type III (Heavy Weather Mooring) are especially high priority, because the ships under repair at these piers and wharves cannot get under way in case of an approaching storm.
- High capacity fittings secure a larger portion of a mooring load at a given facility, and should be assigned higher priority (i.e. a Special Mooring Bollard 'A' holds more load than a 30-in. (76.2 cm) cleat, so the bollard is assigned a higher priority).
- Older facilities not previously pull tested are more likely to suffer from structural deterioration and should be assigned higher priority. Testing recommendations are shown in Table A-1.
- Facilities that do not know the rated load capacities of their mooring fittings should develop a test plan to first estimate the capacities using engineering tools and comparison to similar designs. Then test a sample set of mooring fittings to their estimated capacity by applying incremental loads while monitoring for deflection and other failure modes.

Table A-1 Pull Testing Interval Recommendations

Hardware Priority	Testing Interval	Minimum % of Hardware	Description
High	12 years	20%	For older and very important facilities, up to 100% of fittings can be tested. If any of the tested fittings fail, then testing should be expanded to include a higher percentage of fittings.
Medium	18 years	10%	For older or very important facilities, up to 50% or more of fittings can be tested. If any of the tested fittings fail, then testing should be expanded to include a higher percentage of fittings.
Low	TBD	TBD	A responsible authority should determine what level, if any, pull testing is required.
Mooring Anchors	During installation	100%	All anchors are pull tested during initial installation.

A-3 QUALIFICATIONS.

A-3.1 Personnel.

If contracted, the testing of mooring hardware must be conducted under the direct supervision of a Registered Professional Engineer (P.E.) who has experience in the design and inspection of marine structures. At a minimum, the supervising engineer (P.E.) should be on site and involved in the testing to assess and record conditions encountered using standard engineering practice. NAVFAC EXWC has the capability of providing mooring hardware analysis and testing on a reimbursable funding document for any U.S. government or military agency. All rules governing workplace safety should apply, and it is recommended to have a site safety supervisor available to review safety plans and oversee the work.

A-4 BACKGROUND.

A-4.1 General.

An understanding of the following information regarding the testing of mooring hardware is essential. Each test will consider the following:

- Orientation: The position (X, Y, Z coordinates) of the hardware should be based on the coordinate system established during the mooring hardware inspection. Direction of the forces applied should be established and recorded utilizing the same coordinate system.
- Magnitude: The load applied to the hardware should be 110% of its rated load capacity, applied incrementally while monitoring for deflection and other failure modes. The rated load capacity of the hardware can be gathered from existing data or estimated using engineering tools and comparison to similar designs.
- Duration: The duration that test loads are applied should be dependent upon the level of the test and the discretion of the supervising engineer (P.E.).

A-4.2 Load Path.

The load path followed by the mooring line load through the fitting into the supporting concrete slab can be considered the same for all the mooring fittings.

The mooring line load is applied under the horn or lip at the mooring fitting. The upward vertical load component from the mooring line causes a vertical shear at the base of the horn or lip for loads with nonzero vertical load components. The horizontal load component at the load point induces shear stresses in the cross section of the mooring fitting. The upward tensile force causes tensile stress in the cross section of the mooring fitting as well as a constant bending moment along the mooring fitting axis about a horizontal axis normal to the load. The horizontal load component induces a bending moment that increases with distance from the load point toward the base of the mooring fitting. This bending moment is a maximum at the base of the mooring fitting.

The axial and shear forces and bending moments at the base of the mooring fitting are resisted by the base plate through flexure and shear action. At the bottom of the base plate,

the resulting forces and moments are resisted by the tensile and shear stresses in the anchor bolts. However, a small portion of these forces and moments is resisted by friction between the toe of the base plate and the concrete and by bearing of the vertical sides of the base plate against the adjacent concrete. The shear and tensile forces in the anchor bolts are resisted by the concrete base through bearing, shear and tensile stresses in the slab. The concrete slab transfers these loads from the anchor bolts to the pile cap through shear and tensile stresses and then to the support piles. In turn, the piles transfer the forces to the supporting soil.

A-4.2.1 Load Failure.

The failure of any component along the load path described above from the load point to the ground disrupts the flow of forces unless there are sufficiently strong adjacent parallel load paths to take up the load carried by the failed component. A disruption of the load path can lead to the failure of the load resisting system as a whole.

A-4.3 Supporting Structures.

Consideration of the supporting structure is a critical component of planning a hardware test. Personnel responsible for carrying out the testing program must determine the following:

- The structural adequacy of the system to support the test load.
- General condition of the supporting structure.

Once it is determined that the supporting structure was designed to handle the fitting and the condition of the structure is sound, the test can be carried out.

A-4.4 Failure Modes.

There are various modes of failure associated with mooring hardware. Most cases of failure under in-service conditions occur in the fasteners. When the fitting is embedded in concrete and does not utilize a bolted connection the fitting will generally fail by cracking in areas of high tensile stress or excessive bearing stress. It has been observed that some failures of mooring hardware do not result from mooring line loads. These failures result from overload due to vehicular impact, cranes accidentally setting loads upon the fitting, and other miscellaneous incidents. This type of failure should be observed prior to conducting a load test and should be grounds to abort the test. Mooring hardware with obvious distress must be taken out of service immediately.

Failure under load test is generally associated with corrosion of the fasteners or failure of the supporting structure. The following methods should be used for detection of failure:

- Visual observation of distress or movement.
- Measured permanent yielding or displacement following release of test loads.
- Observation of cracking.

A-5 METHODS.

A-5.1 General.

The purpose of a hardware test is to ensure that the mooring hardware is capable of holding its design load. If a mooring fitting fails, take out of service immediately and replace or repair as soon as possible. Several general methods exist to test fittings:

A-5.1.1 Pull Testing.

There are four methods of pull testing:

- Pull test with a test rig, which may include jacking equipment.
- Pull test with a land-based crane or winch.
- Pull test with a water-based crane or winch.
- Pull test similar mooring hardware one-against-the-other to test two pieces of mooring hardware at once using weight handling equipment to apply the load.

A-5.1.2 Bolt Testing.

Fasteners transmit the load to the structure and are often the critical component in many fittings. Therefore, consider testing the bolts in lieu of testing the entire hardware if the mooring fittings are in good condition. Bolts act in tension and shear to resist loads applied to mooring fitting. Since most mooring fittings are set in a grout or concrete base and have shear keys integral with the fitting, most of the shear stresses are resisted by the concrete or grout base. This is not the case on structures constructed of timber or steel where all loads are resisted by the fasteners. If the fitting is set in concrete, the fasteners need only to be tested in tension. In cases such as timber structures or steel structures, the fasteners are readily accessible and can be removed for inspection, eliminating the need for in-situ load test. Bolts that have their anchorage in concrete should be load tested in tension using the procedures outlined in ASTM E 488, *Standard Test Methods for Strength of Anchors in Concrete and Masonry Elements*. Ultrasonic or other non-destructive testing may also be utilized before pull testing to detect voids, cracks, corrosion, and other discontinuities along the bolts. It should be noted that tension and testing of fasteners will not provide a comprehensive indication of load capacity of the system.

The bolt testing procedure is:

- Remove the grout and nuts from the bolts.
- Pull-test each bolt to 110% of its working load using a pull test rig. The pull test procedure must follow the procedure for testing anchors described in ASTM E 488, *Standards Test Methods for Strength of Anchors in Concrete and Masonry Elements*.
- If test is successful, reinstall the nuts and grout to the design condition.
- If bolt fails, take out of service and replace as soon as possible.

A-5.2 Results.

Load testing results are reported on the form provided in Figure A-1. Remove any mooring hardware that does not pass the pull test and plan and allocate resources for appropriate replacement.

A-5.3 Levels of Load Testing.

- Level 1 - Bolt pull test (tension). Bolts are tested individually to determine tensile strength of the bolt and anchorage.
- Level 2 - Indirect line load. Mooring fittings are pull-tested with actual line force but not in actual direction of mooring line due to cost and convenience, e.g., bollard-to-bollard pull. This level of testing will confirm the strength of the mooring hardware system including the casting, fasteners, and structure.
- Level 3 - Load applied in actual direction of mooring line force. This will confirm the working load of the entire system including base structure, anchor bolts, and fitting.

A-5.4 Testing Procedure.

A-5.4.1 Test Prerequisites.

Area adjacent to fitting to be tested should be open and clear of vehicles, vessels, or other equipment and associated personnel.

A-5.4.1.1 Prior to Testing.

Prior to testing, a review should be conducted of the test equipment by qualified personnel to determine its adequacy for the loads to be applied.

A-5.4.1.2 Fittings.

Fittings should not exhibit outward signs of distress or failure prior to conducting a load test.

Figure A-1 Example Deck Fitting Load Test Report

MOORING FITTING LOAD TEST REPORT		Fitting No.:
Pre-Test Condition:		
<u>Casting</u>	<u>Anchor Bolts</u>	<u>Concrete Foundation</u>
<u>Size:</u>	<u>Size:</u>	<u>Geometry:</u> (dimensions, height above deck)
<u>Type:</u> <u>Condition:</u> (paint, rust)	<u>Type:</u> <u>Condition:</u> (lead fill, paint, rust)	<u>Condition:</u> (cracks, spalls, stains)
_____	_____	_____
_____	_____	_____
<u>Distress: (cracks, abrasions)</u>		<u>Design load capacity: (known / estimated)</u>

Description of Testing Method _____ Pull Test _____ Bolt Test		
Fitting Position: (with respect to reference point)		
Pre-Test Coordinates		Post-Test Coordinates
X = _____		X = _____
Y = _____		Y = _____
Z = _____		Z = _____
TEST DATE: _____		TEST LOAD: _____
LOAD HELD FOR: _____(sec)		(incremental at 10% steps)
Test Time: Start _____ Finish _____		TEST ANGLE: _____
RESULTS: (Record any manifestation of distress observed, change to cracks in foundation, rust flakes shed, foundation movement, fitting rotation, distortion, fastener yield, etc.)		

Test Director: _____		Date: _____

A-5.4.2 Test Preparation – General.

A-5.4.2.1 Testing Personnel.

Testing personnel should provide test rigs, jacks, pumps, wire rope rigging, surveying instruments for measuring deflection and movement (such as an optical level or a total station), chain falls and dynamometer, and all subject matter expertise as required to perform the test.

A-5.4.2.2 Precautionary Measures.

Precautionary measures should be taken to prevent damage to the fitting, dock structure, or fender system. Lumber blocks, sheet copper, etc. should be provided to prevent chafing and rope burns as necessary. Where needed, rubber padding should be provided to absorb and distribute point loads on concrete.

A-5.4.2.3 Monitoring Points.

Monitoring points should be established on the fitting or fastener to track movement under load. Movement should be recorded in the three principal axes. A reference point independent of the fitting or fastener and its foundation should be established to find movement. Surveying methods can be employed to track movement from a safe distance. A target could be affixed to the fitting and readings taken (X, Y, Z) during the test.

A-5.4.2.4 Base.

The strip of concrete surrounding the base plate of each fitting and the surface of the free edge of the concrete in front of the fitting must be visually inspected for shear cracks. To aid in the detection of potential shear cracks, it is recommended that an approximately 1 ft (0.3 m) wide strip surrounding the base plate and the surface of the free edge of the concrete in front of the fitting, be painted with whitewash or light-colored brittle paint.

A-5.4.3 Test Precautions.

A-5.4.3.1 Standards.

Perform all work operations in accordance with the safety standards identified in APPENDIX C (such as U.S. Army Corps of Engineers EM-385-1-1 and OSHA Standards). Provide U.S. Coast Guard (USCG) approved life jackets or buoyant work vests to employees working over or near water, where the danger of falling into the water and/or drowning exists. Evaluate the requirement for the use of personal floatation devices (PFDs) on piers, taking into consideration falling/tripping hazards, proximity to edge, obstacles/obstructions, availability and placement of life rings with lines, access ladders, etc. Follow site specific weight handling equipment safety rules as required.

A-5.4.3.2 Provisions.

Provisions should be made for keeping personnel not involved in the test clear of the test site and any danger areas.

A-5.4.4 Test Procedure.

A-5.4.4.1 Horizontal Pull.

Using the test rig, chain falls, dynamometer, etc. and a wire rope pendant, begin by exerting a pull equivalent to 10% of the rated load capacity for the mooring fitting or fastener. Application of the load should be 4 in. (102 mm) below the lip, horn, or other line holding device on fittings. Increase the load incrementally, in 10% steps or as directed by the test engineer. Hold each incremental load for one minute or as directed by the test engineer, monitoring for deflection, movement, and other failure modes. Increase to a final load of 110% of the rated load capacity. The 110% load should be held for 10 minutes. At the end of 10 minutes, the fitting or fastener should be examined for any evidence of failure and any deformation, movement, or other failure modes recorded. Slowly remove the load from the fitting after recording all information.

The results should be recorded on the load test record sheet.

A-6 REPORTING.

All results of testing should be recorded on the deck fitting load test record shown in Figure A-1 or a similar record sheet. These records should be included in the report described in Section 5 of this document.

This Page Intentionally Left Blank

APPENDIX B GLOSSARY

B-1 ACRONYMS.

AFCEC	Air Force Civil Engineer Center
ASTM	American Society for Testing and Materials
ASQ	American Society for Quality
BIA	Bilateral Infrastructure Agreement
DoD	Department of Defense
EXWC	Engineering and Expeditionary Warfare Center
HNFA	Host Nation Funded Construction Agreements
HQUSACE	Headquarters, U.S. Army Corps of Engineers
MLLW	Mean Lower Low Water
MST	Mooring Service Type
NAVFAC	Naval Facilities Engineering Command
P.E.	Professional Engineer
PFD	Personal Floatation Device
SOFA	Status of Forces Agreements
UFC	Unified Facilities Criteria
U.S.	United States
USCG	United States Coast Guard

This Page Intentionally Left Blank

APPENDIX C REFERENCES

C-1 GOVERNMENT PUBLICATIONS.

NAVAL FACILITIES ENGINEERING COMMAND (NAVFAC)

MO 124, *Mooring Maintenance Manual*

UNIFIED FACILITIES CRITERIA (UFC)

<https://www.wbdg.org/ffc/dod>

UFC 1-200-01, *DoD Building Code*

UFC 4-150-07, *Waterfront Facilities Operations and Maintenance*

UFC 4-150-09, *Permanent Anchored Moorings: Operations and Maintenance*

UFC 4-152-01, *Piers and Wharves*

UFC 4-159-03, *Moorings*

C-2 NON-GOVERNMENT PUBLICATIONS.

AMERICAN SOCIETY OF CIVIL ENGINEERS (ASCE)

<https://www.asce.org/>

ASCE MOP 130, *Waterfront Facilities Inspection and Assessment*

AMERICAN SOCIETY FOR TESTING AND MATERIALS (ASTM)

ASTM E 488, *Standard Test Methods for Strength of Anchors in Concrete and Masonry Elements*

AMERICAN SOCIETY FOR QUALITY (ASQ)

ASQ Z1.4, *Sampling Procedures and Tables for Inspection by Attributes*

ASQ Z1.4, *Sampling Procedures and Tables for Inspection by Variables for Percent Nonconforming*